

# ET3296 Cermet Trimming Potentiometer

**ELECSOUND®**

## Features:

Square/Multiturn/ Cermet/ Industrial/ Sealed  
5 Terminal Styles  
RoHS Compliant

## Electrical Characteristics

Standard Resistance Range: 10Ω - 2MΩ  
Resistance Tolerance: ±10% std.  
Absolute Minimum Resistance: ≤1% or 2Ω  
Contact Resistance Variation: ≤1% or 1Ω  
Insulation Resistance : R1 ≥ 1,000 MegΩ  
Withstand Voltage : 640VAC  
Effective Travel: 28 turns normal

## Environmental Characteristics

Power Rating:(350V max.)0.5W@70°C, 0W@150°C  
Temperature Range: -55°C to +150°C  
Temperature Coefficient: ±100ppm/°C  
Vibration: 10-500Hz, 0.75mm, 6Hour: ΔR ≤ ±5%  
Shock: 390m/s, 4000cycles, ΔR ≤ ±5%  
Electrical Endurance:0.5W@70°C,1000H,ΔR ≤ 10%  
Rotational Life: 200Cycles,ΔR ≤ ±5%

## How to order:

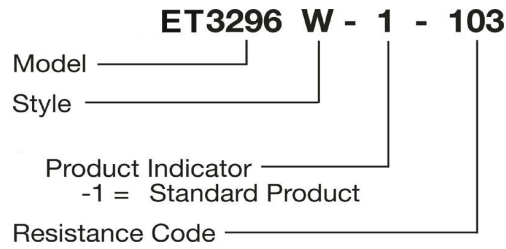

## Standard Resistance Table:

Resistance (Ohms)	Resistance Code
10	100
20	200
50	500
100	101
200	201
500	501
1000	102
2000	202
5000	502
10000	103
20000	203
25000	253
50000	503
100000	104
200000	204
250000	254
500000	504
1000000	105
2000000	205

## Physical Characteristics

Starting Torque: ≤35mN·m  
Flammability: UL.94V-0  
Marking: Resistance code, Model  
Standard Packaging: 50pcs per tube

## Common Dimensions

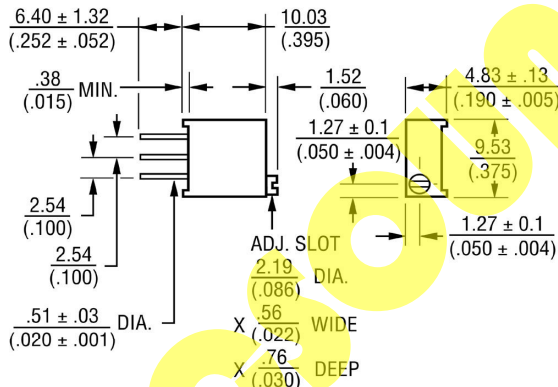
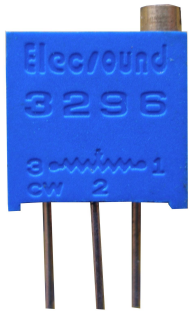

**3296Y**

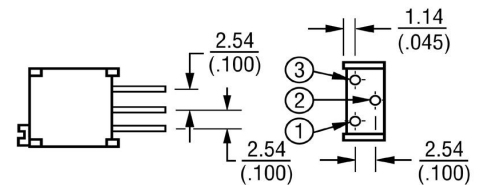

**3296P**

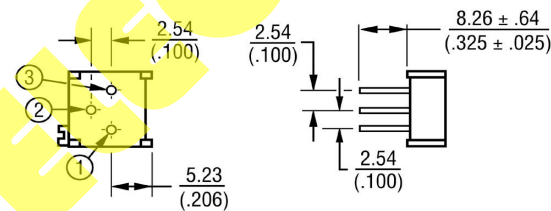

**3296Z**

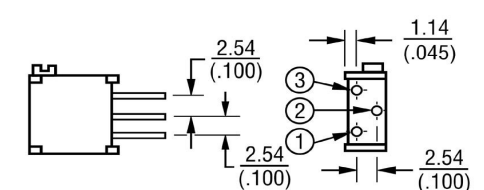

**3296W**

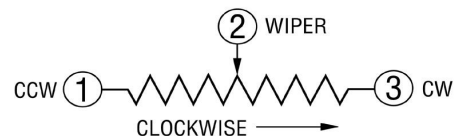
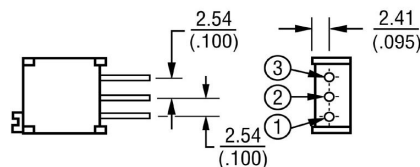

**3296X**

